

F. P. DUNN.
CHEESE CUTTER.

APPLICATION FILED AUG. 12, 1903.

3 SHEETS—SHEET 1.

Fig. 1.

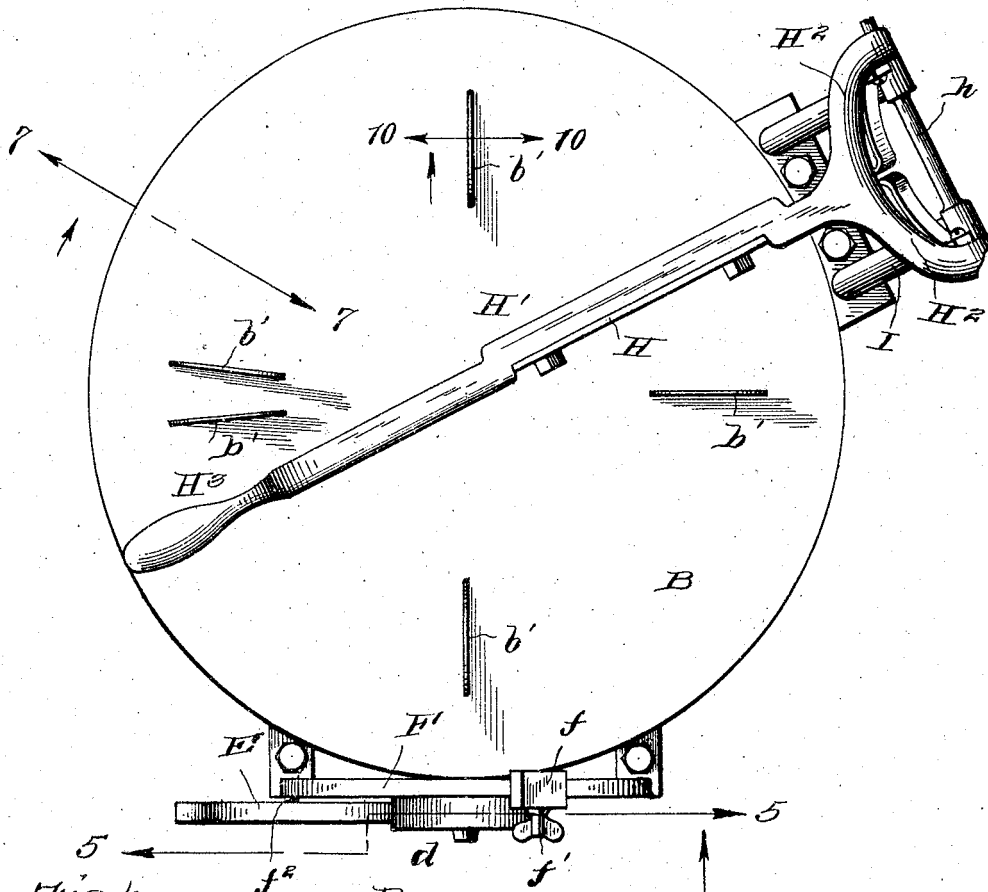

Fig. 6.

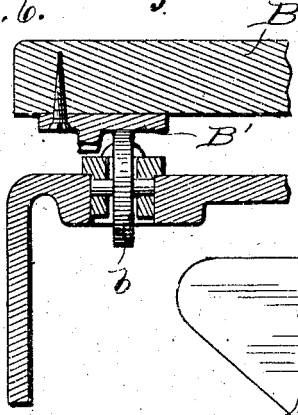

Fig. 8.

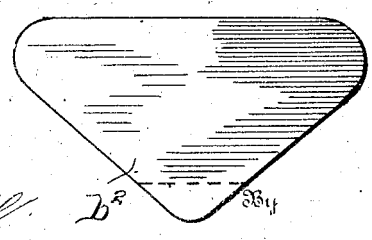
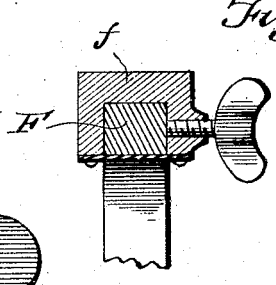

Fig. 7.



Witnesses

R. A. Boswell.
George M. Anderson.

Inventor

Frank P. Dunn,

E. W. Anderson

his Attorney

F. P. DUNN.
CHEESE CUTTER.
APPLICATION FILED AUG. 12, 1903.

Fig. 2.

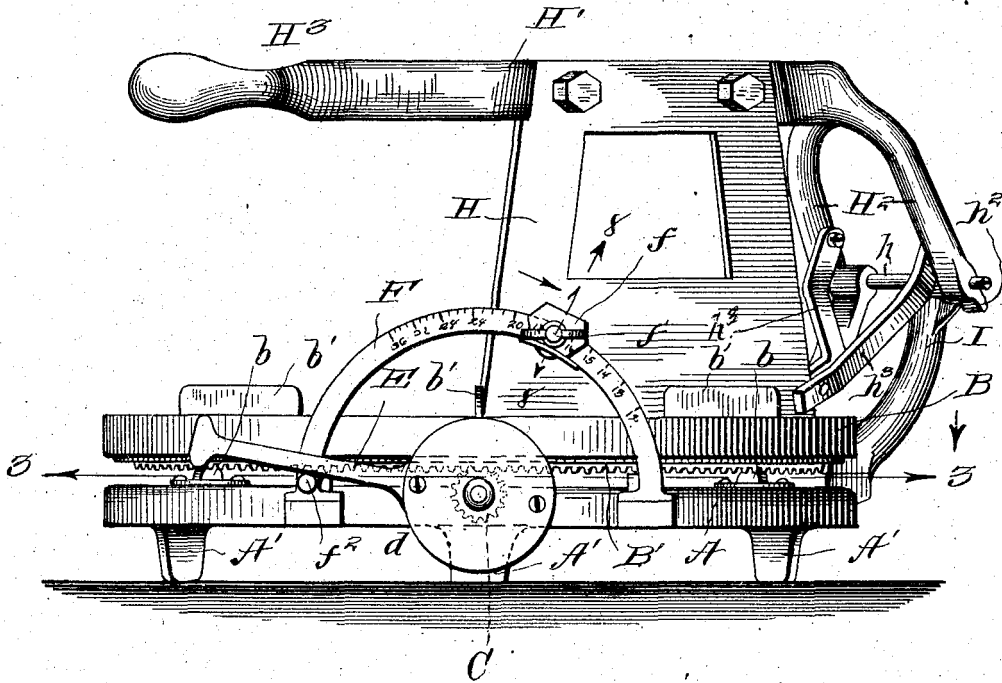
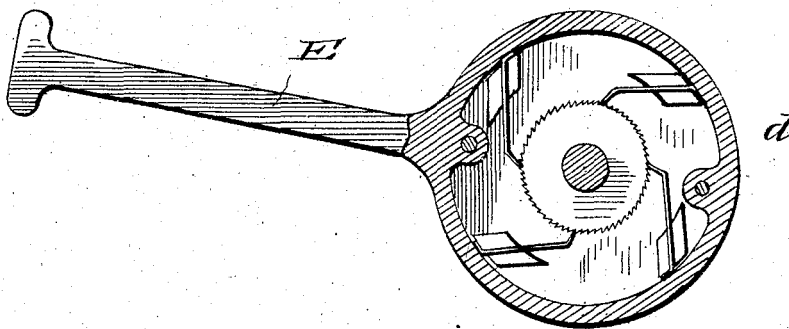

Fig. 5.



Inventor

Frank P. Dunn,

Witnesses

R. A. Boswell,
George M. Anderson

By

E. W. Anderson
his Attorney

F. P. DUNN.
CHEESE CUTTER.

APPLICATION FILED AUG. 12, 1903.

3 SHEETS—SHEET 3.

Fig. 5.

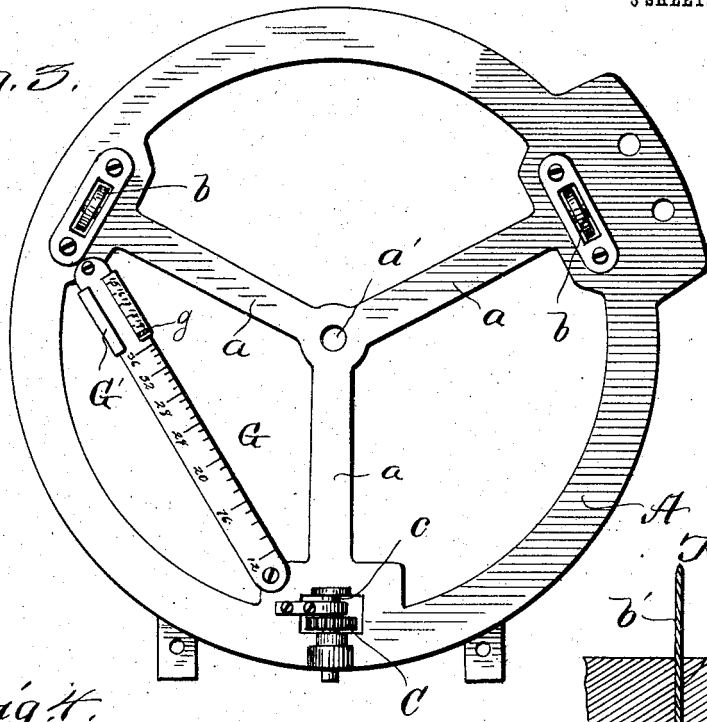
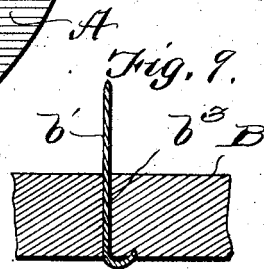
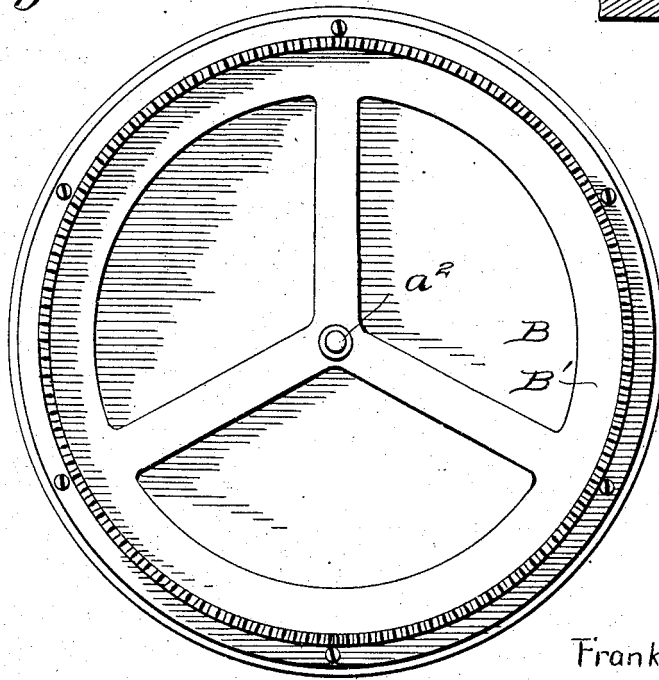

Fig. 4.



Inventor

Frank P. Dunn,

Witnesses

R. A. Boswell.
George M. Anderson.

By

E. W. Anderson
his

Attorney

UNITED STATES PATENT OFFICE.

FRANK P. DUNN, OF ANDERSON, INDIANA, ASSIGNOR TO COMPUTING CHEESE CUTTER COMPANY, INCORPORATED.

CHEESE-CUTTER.

SPECIFICATION forming part of Letters Patent No. 790,564, dated May 23, 1905.

Application filed August 12, 1903. Serial No. 169,202.

To all whom it may concern:

Be it known that I, FRANK P. DUNN, a citizen of the United States, and a resident of Anderson, in the county of Madison and State of Indiana, have made a certain new and useful Invention in Cheese-Cutters; and I declare the following to be a full, clear, and exact description of the same, such as will enable others skilled in the art to which it appertains to make and use the invention, reference being had to the accompanying drawings, and to letters of reference marked thereon, which form a part of this specification.

Figure 1 is a top plan view of the invention. Fig. 2 is a side view of the same. Fig. 3 is a top plan view of the base. Fig. 4 is a bottom plan view of the revolving carriage. Figs. 5, 6, 7, 8, and 9 are detail views.

This invention has relation to cheese-cutters, and has for its object the provision of a computing cheese-cutter of simple and durable character wherein there will be no lost motion of the rotating devices for the cheese or any movement of the cheese itself with relation to its board or rest.

A further object of my invention is to provide an operating member for the cheese-carrying table and intermediate connections between this operating member and the table by means of which a very material movement of the operating member must be made for a comparatively small movement of the cheese-carrying table and also such that the movement of the operating member can only serve under ordinary conditions to move the cheese-carrying table in one direction.

Other objects and advantages will hereinafter appear.

The invention consists in the novel construction and combinations of parts, as hereinafter set forth.

Referring to the accompanying drawings, the letter A designates the main frame or base, cast in one piece and of general annular form, having radial braces *a* and provided with a bearing recess *a'* at their juncture, the frame being mounted upon suitable supports or legs *A'*.

B is the cheese rest or table, composed of

wood and having secured to its lower face the skeleton-form crown-wheel *B'*, resting centrally upon frame A on projection *a''*, engaging recess *a'*, and having its metal rim resting at two points upon antifriction-rollers *b* of the frame A and at the third point having said crown-wheel in mesh with the pinion C upon shaft *c*, provided with bearings in frame A and arranged radially of said frame. The table B has projecting from its upper face the radial spurs or catches *b'*, having tapered lower end portions *b''*, designed to be forced into tapered radial slots *b'''*, sawed through the table and clenched beneath the table, in this way providing a secure and positive engagement which will prevent any movement of the spurs with relation to the table. The metal crown-wheel secured to the bottom of the wooden table will prevent warping thereof.

The shaft *c* of pinion C has a single-acting clutch connection *d* with handle-lever E, whereby the pinion is turned upon movement of said lever in one direction only. Said pinion and clutch constitute a reducing-gear driving mechanism or connecting-train between the operating lever or member and the table, by which a very considerable movement of the operating-lever is required for a comparatively small angular advancement of the table.

The computations for varying the extent of movement of the rotary table are obtained as follows: F is a semicircular bar resting at its ends upon frame or base A, to which it is secured, and carrying upon its front face numbered graduations representing the total weights of cheese upon the table to be cut, from twelve to thirty-six pounds, such weights being ascertained when the cheese is first placed on the table and before it is cut. An adjustable stop *f* is secured by set-screw *f'* at the proper point or graduation, whereupon the handle-lever E is moved backwardly until it strikes rigid or stationary stop *f''* and then moved forwardly until it strikes adjustable stop *f'*, when the table and cheese will have been rotated the required distance off the amount of cheese to be cut by the knife H, hereinafter described.

In the drawings the arc-bar F is provided

with graduations founded upon the ordinary retail price of twenty cents per pound for cheese, and the division "12" on said arc-bar is such distance from the stop f^2 that a movement of the lever E from the stop f^2 to the mark "12" will cause the cheese-carrying table B to move through one forty-eighth of a complete revolution, so that a twelve-pound cheese may be divided into forty-eight pieces, which at five cents each would amount to two dollars and forty cents, the price of a twelve-pound cheese at twenty cents per pound. The mark "24" is placed half-way between the mark "12" and the stop f^2 . The mark "36" is one-third way between stop f^2 and the mark "24," and the other marks are arranged in the same way.

In estimating the amount of cheese to be cut resource is had to the scale-bar G, secured to the base A and having marked thereon numbered graduations from "12" to "36," representing total weights of cheese to be cut in pounds. G' is a slide adjustable upon said scale-bar and having marked thereon numbered graduations representing the prices per pound at which the cheese is to sell, or fifteen, sixteen, seventeen, eighteen, and nineteen cents, and to the right of the graduation representing nineteen cents a line g colored red and similarly spaced with the other graduations. The principle upon which the scales of G and G' are laid out is that of the well-known slide-rule, in which the scales are logarithmic and the operations of multiplying and dividing are performed mechanically. The object in the present case is to divide the number representing the total weight of the cheese by the factor to give the proper adjustment of the stop f for any selling price other than twenty cents per pound. In estimating where to adjust stop f upon the circle-bar to cut five cents worth of cheese at one forward movement of the handle-lever the slide G' is adjusted until the figure on the slide representing the price at which the cheese is to sell per pound corresponds or registers with the total weight of cheese upon the scale-bar. The red line g to the right of the numbered graduations upon slide G' will then indicate upon the scale-bar the figure upon the circle-bar having similar graduations to those of the scale-bar G where the adjustable stop must be set to cut five cents worth of cheese. This calculation is made but once for the whole cheese. This is on the principle that if the stop f is set at a point that represents less than the actual total weight of cheese upon the board the table will be moved a distance measuring off more than a quarter of a pound. If the stop is set at a figure that represents eighteen-twentieths of the actual weight, a forward movement of the handle-lever will rotate the table a distance measuring off five cents worth of cheese at eighteen cents per pound. If the stop is set at fifteen-twentieths of the actual weight and

the handle-lever operated as above, five cents worth of cheese at fifteen cents per pound will be measured off.

Referring now to the knife H for cutting the cheese, this device consists of a quadrangular blade bolted at its upper end to the inner end portion of the one-piece knife-lever H', having a rearward depending inclined branched extension H², pivoted by bolt h to elevated inclined forked frame I, secured to and extending outwardly from the base A, any lateral play of the knife being thereby avoided, said frame H' having a rear handle extension H³ projecting over the forward half of the table, the knife H being located over the rear half of the table. This knife-blade H is braced to lever H' at h^3 . The pivot-bolt h is located just midway of the table and knife-lever, causing the inner limiting cut of the knife to be as nearly as possible coincident with the center line of the cheese and requiring the knife to be sharpened upon one edge only. The knife-frame and its blade are held in elevated position free from the cheese when not in use by means of projection h^2 beyond the pivot of extension H² and engaging a stop h^3 of the elevated frame I.

The table B may be readily lifted from the base A for the purpose of placing a cheese upon it.

Having thus described my invention, what I claim, and desire to secure by Letters Patent, is—

1. In a cheese-cutter, the combination of, a base, a rotary table, a vertically-swinging pivoted handle-lever, means consisting in part of a clutch connecting said handle-lever and table for rotating the table, and a vertical arc-bar having a series of graduations representing cheese weights, and an adjustable stop upon said arc-bar for varying the extent of movement of said handle-lever, substantially as specified.

2. In a cheese-cutter, the combination of, a base, a table upon said base and having an annular series of teeth, a knife-lever, said lever and base having rear outwardly-inclined meeting extensions located without said base and table and having a pivotal connection at a point midway of the table and knife-lever, said lever having a handle extension lying within said base and table, a knife-blade fixed to the inner end portion of said lever and located over the rear half of said table, and means independent of said knife-lever for rotating said table, and including a pinion engaging said series of teeth, a handle-lever, and a clutch between said lever and the shaft of said pinion, substantially as specified.

3. In a cheese-cutter, the combination of, a base, a rotary table having an annular series of teeth, means for rotating said table including a pinion engaging said teeth, a handle-lever and a single-acting clutch between said

lever and the shaft of said pinion, substantially as specified.

4. In a cheese-cutter, the combination of, a rotary table having an annular series of teeth, means for rotating said table including a pinion engaging said teeth, a handle-lever, and a clutch between said lever and the shaft of said pinion, an arc-bar adjacent said handle, and bearing a series of graduations representing the total weights of cheese, and an adjustable stop upon said arc-bar for varying the extent of movement of said handle, substantially as specified.

5. In a cheese-cutter, the combination of, a base, a rotary table, a vertically-swinging handle-lever, a single-acting clutch driving connection between said lever and table, and a vertical arc-bar provided with stops and arranged adjacent said lever and cooperating therewith, whereby reciprocation of said handle-lever with relation to the vertical arc-bar will cause step-by-step rotary movement of the table in one direction.

6. In a cheese-cutter, the combination of, a base, a rotary table, a vertically-swinging handle-lever, a single-acting clutch driving connection between said lever and table, and a vertical arc-bar arranged adjacent said lever and carrying indications to serve as a guide to indicate the angular movement of the lever.

7. In a cheese-cutter, the combination of, a base, a rotary table, a gear carried by said table, a pinion engaging said gear, an operating member, and a single-acting clutch between said operating member and the pinion.

8. In a cheese-cutter, the combination of, a base, a rotary table, a gear carried by said table, a pinion engaging said gear, an operating member, a single-acting clutch between said operating member and the pinion, and an indicator arranged adjacent said operating member and carrying indications to serve as a guide for the movement of said operating member.

9. In a cheese-cutter, the combination of, a base, a rotary table, an operating-lever, a reducing-gear driving connection between said operating-lever and the table, said reducing-gear driving connection consisting in part of a single-acting clutch, whereby a large movement of the operating-lever is required for a small

angular movement of the table and a movement of the operating-lever will serve to automatically drive the table in one direction only.

10. In a cheese-cutter, the combination of, a base, a rotary table mounted thereon to rotate in a substantially horizontal plane, an operating-lever, a reducing-gear driving connection between said operating-lever and the table, said reducing-gear driving connection consisting in part of a single-acting clutch, whereby a large movement of the operating-lever is required for a small angular movement of the table and a movement of the operating-lever will serve to automatically drive the table in one direction only.

11. In a cheese-cutter, the combination of, a base, a rotary table mounted thereon to rotate in a substantially horizontal plane, a vertically-swinging handle-lever, a single-acting clutch driving connection between said lever and table and a vertical arc-bar, provided with limiting-indicators, carried by the base and arranged adjacent said lever and cooperating therewith, whereby reciprocation of said handle-lever with relation to the vertical arc-bar will cause step-by-step rotary movement of the table in one direction only.

12. In a cheese-cutter, the combination of, a base, a rotary table, a vertically-swinging pivoted handle-lever, means consisting in part of a clutch connecting said handle-lever and table for rotating the table, a vertical arc-bar having a series of graduations, and an adjustable stop upon said arc-bar for varying the extent of movement of said handle-lever.

13. In a cheese-cutter, a knife for severing portions of cheese, a scale for regulating the size of portions into which the cheese is to be severed, and a vertical arc-bar carrying such scale, a stop thereon, a radial lever, and means operative in connection with such lever, arc-bar and scale for controlling the movement of the cheese to the knife.

In testimony whereof I affix my signature in presence of two witnesses.

FRANK P. DUNN.

Witnesses:

JEWELL TAYLOR,
OBED KILGORE.